



Express your individual style with custom made timber entrance combinations for your home or business



Specifications

- Victorian Ash frame or FSC® certified Manilkara Bidentata
- IV 78mm for triple glazing and Passive House
- IV 68mm for double glazing
- Choice of glass combinations
- Low VOC spray-painted or stained in the colour of your choice
- Increased security with multi-point locking
- Automation can be integrated
- Suitable for Passive House and some designs can be made for all bushfire areas

- Timber or aluminium threshold
- Custom made to your design or ours
- German hardware fittings
- Seals to reduce drafts and noise
- Very energy efficient

Energy rating from a very low 1.4

Entrance doors are available only as a full package including door jamb, threshold, multi-point locking system and door furniture.

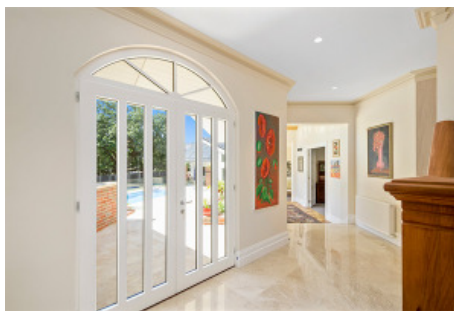

**SECTION A - A
OUTWARD OPENING**

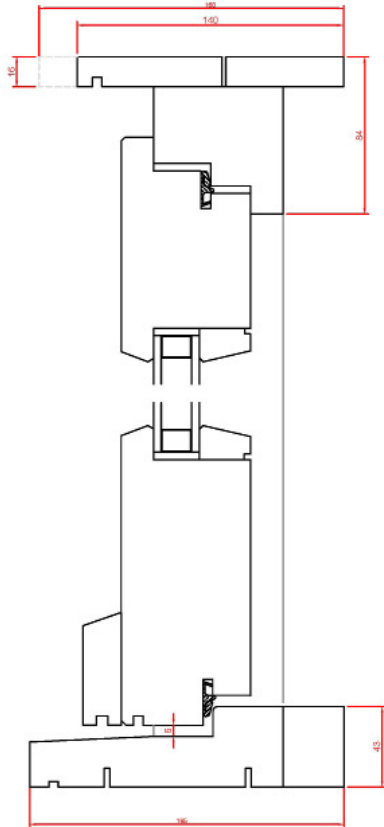

**SECTION A - A
INWARD OPENING**

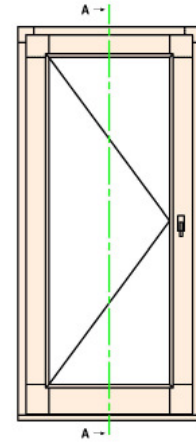
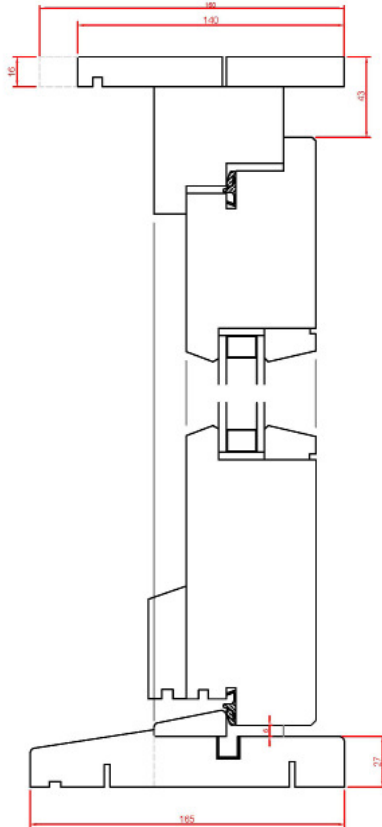

**SECTION B - B
OUTWARD OPENING**

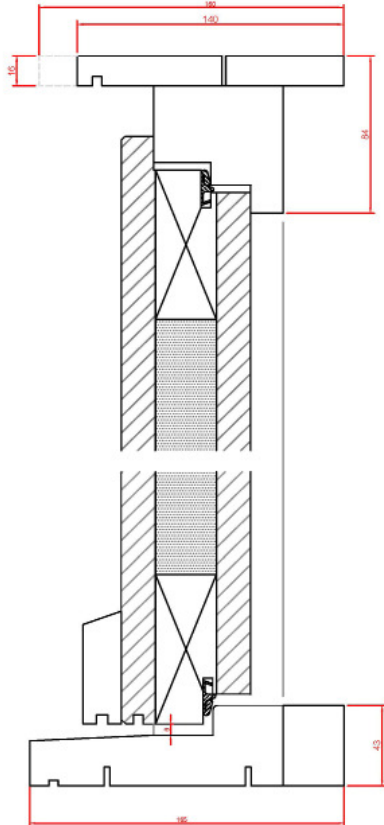

**SECTION B - B
INWARD OPENING**

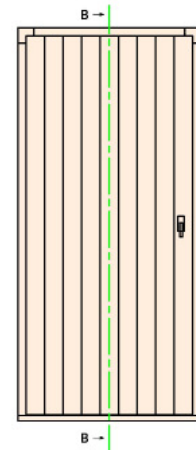
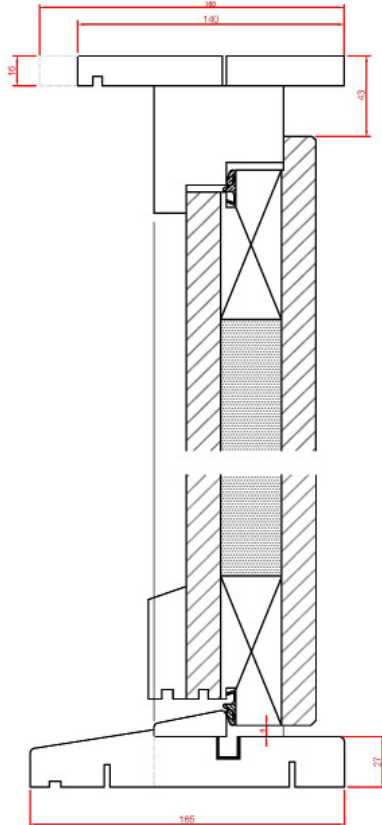

Paarhammer Pty Ltd
 53 Haddon Drive
 Po Box 26, Ballan VIC. 3342
 tel: 03 5368 1999
 fax: 03 5368 1993
 email: mail@paarhammer.com.au
 url: www.paarhammer.com.au

Scale
 Do not scale drawings
 © Copyright Paarhammer Pty Ltd
 subject to change without notice
 Drawn
Andrew Ferguson

Job/Drawing Name
**Entrance Doors with Reveals
 Glass and Solid Vertical Sections**

Job No **D68A053**
 Date **25/11/20**

Size
A0